

Section 8 COMMERCIAL SADDLE THRESHOLDS

Standard Sizes (Product is cut oversize to allow "cutting in"): 30", 32", 36", 42", 48" (cut 3/8" over); 60", 64", 72" (cut 1" over). Other lengths are available (Extra cost over 73").

Routed thresholds (page 33) and specified lengths are cut exact. Center holes are counter-sunk. #10 phillips flathead screws of appropriate length are included. Nominal min. wall thickness 1/8". Tabs avail. for 1/2" saddles. (page 33)

Special anchors may be required on concrete slab construction & are available at extra cost, see page 46.

 Barrier free design meets ADA requirements.

1502 A, B
10 x 1" phillips flathead screws are included.

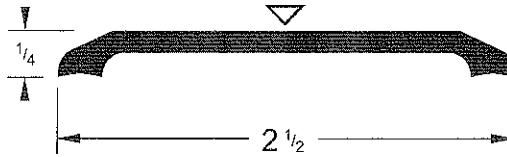

1503 A, B
10 x 1" phillips flathead screws are included.

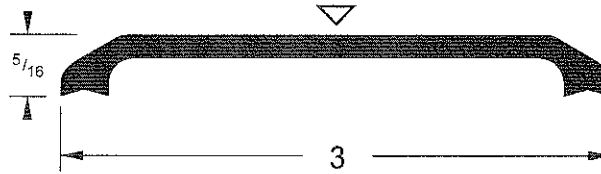

1/2" COMMERCIAL SADDLE THRESHOLDS

10 X 1-1/2" phillips flathead screws are included with parts 1504 - 1507

1504 A, B

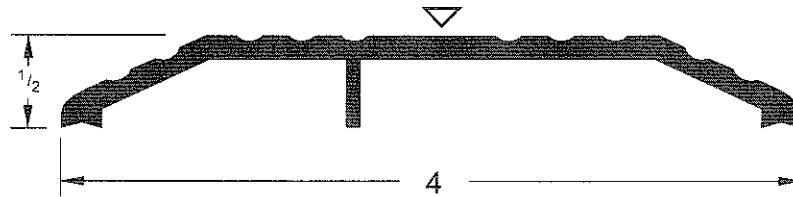

1505 A, B

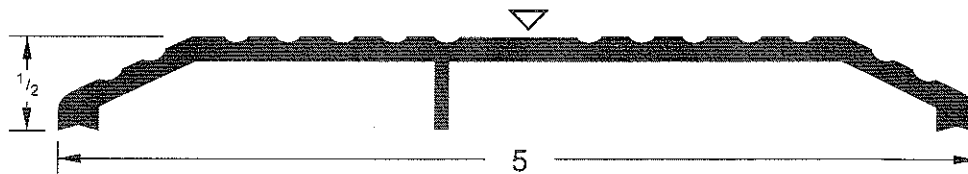

1506 A, B

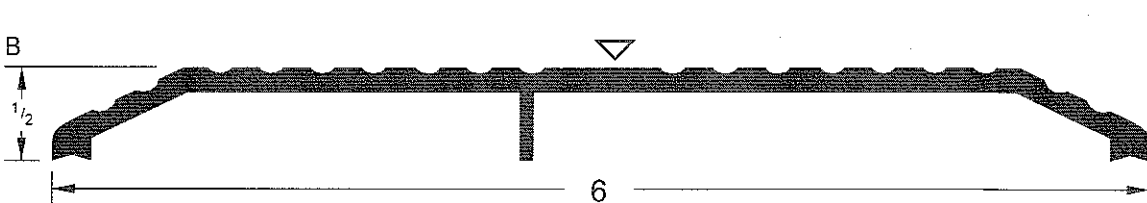

1507 A, B

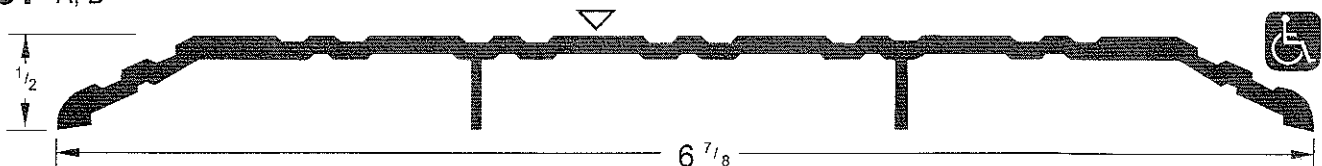

HEAVY DUTY COMMERCIAL SADDLE THRESHOLDS

10 x 1-1/2" phillips flathead screws are included.

1525 A, B

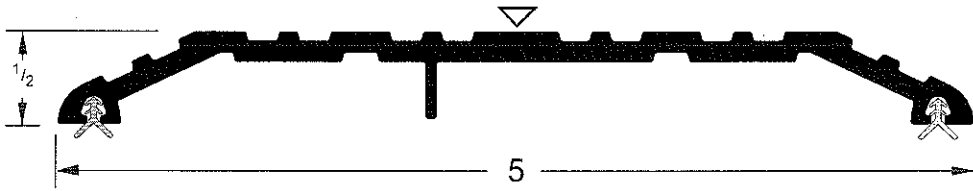

1516 A, B

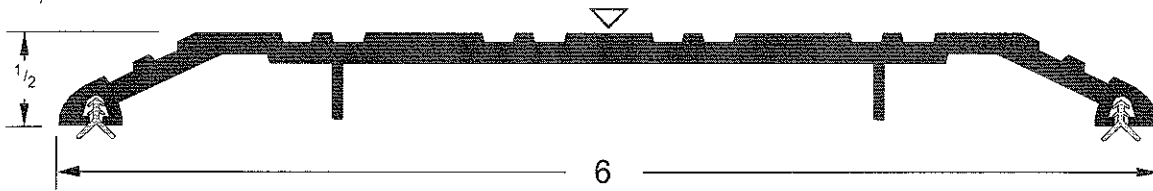

1517 A, B

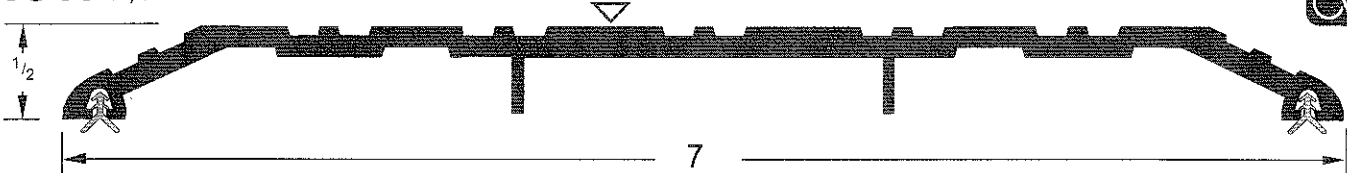

1518 A, B

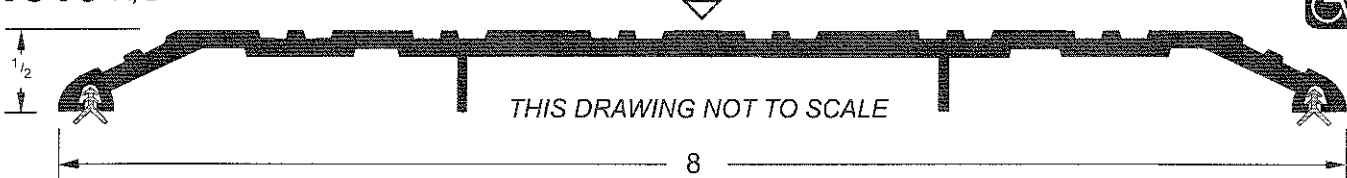

1509 A, B

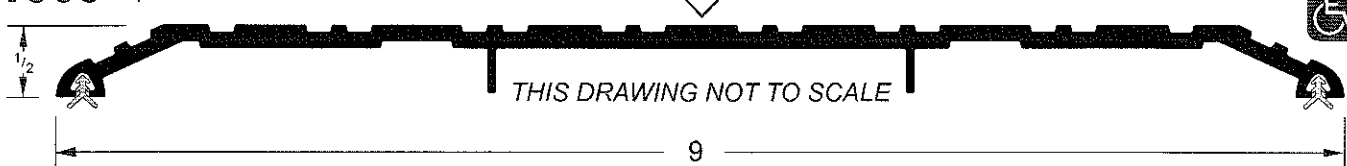

ROUT FOR METAL/MORTISED FRAMES

(RMF) A milling operation to remove aluminum, enabling the threshold to be "dropped" into place.

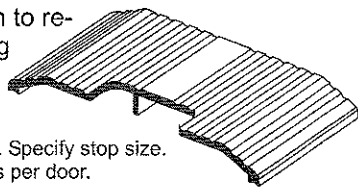

Order: Exact length required. Specify stop size.
Holes: Three (3) center holes per door.

TABS

Tabs can be attached to 1/2" commercial saddle thresholds to facilitate the connection between thresholds and wood frame.

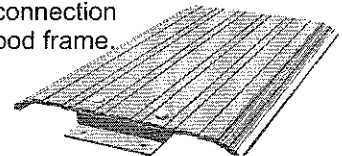

Order: Exact length required.
Holes: No center hole.

SADDLE THRESHOLDS WITH SCREW BOSS

1519 A, B

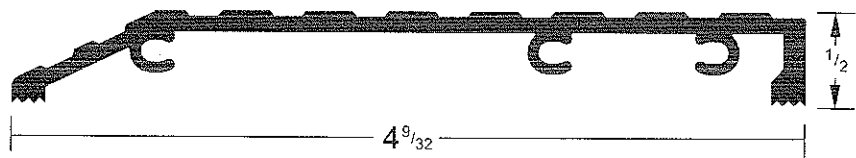

1529 A, B

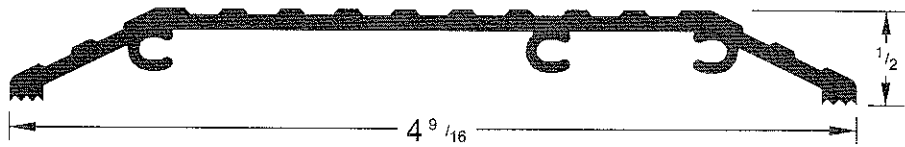

1539 A

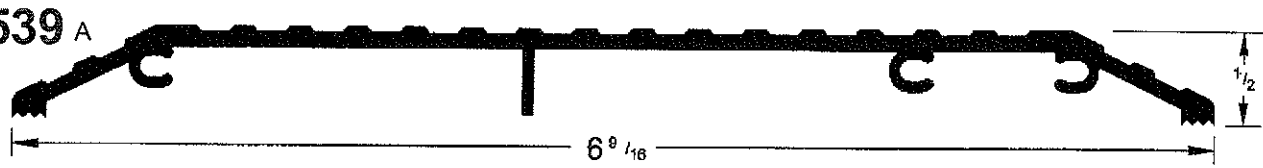

1/4" COMMERCIAL SADDLE THRESHOLDS

10 X 1" phillips flathead screws are included.

1544 A, B

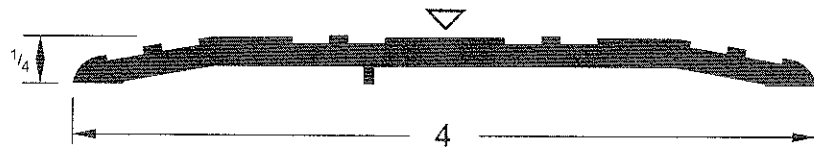

1545 A, B

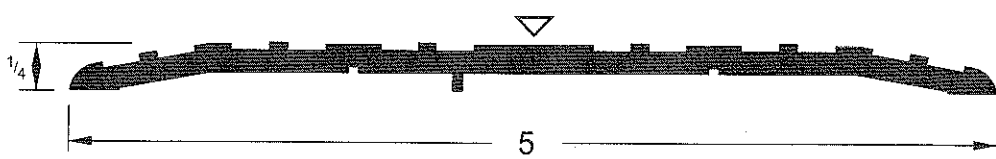

1546 A, B

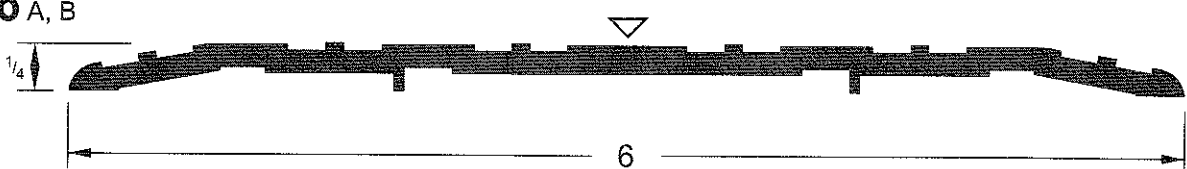

1547 A, B

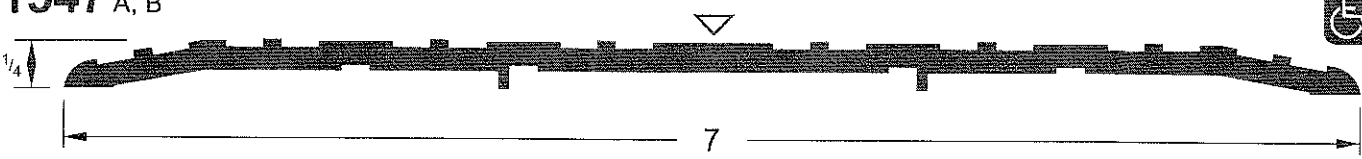

1548 A, B

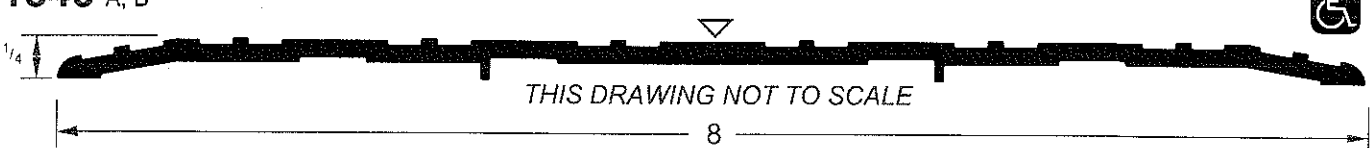

THERMAL BREAK SADDLE THRESHOLDS

10 x 1-1/2" phillips flathead screws are included.

1512 A, B

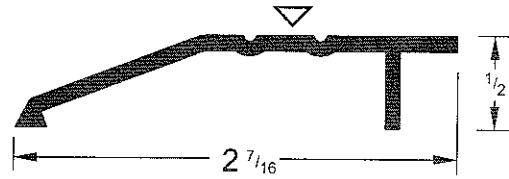

1511 P



Black rigid vinyl thermal break connector to join saddles.



1514 A, B

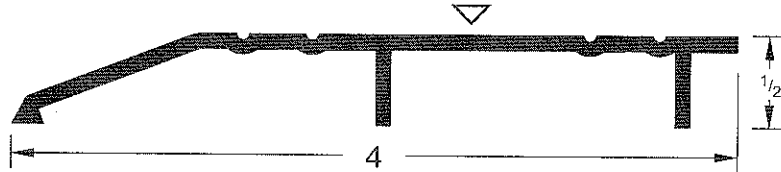

1515 A, B

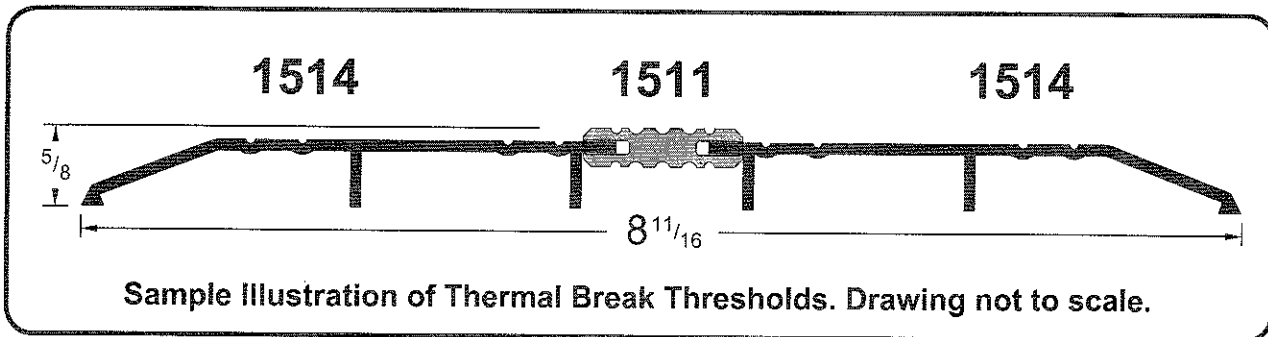
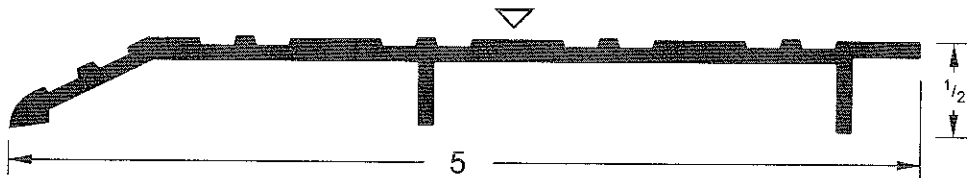

ELEVATORS

3105 A, B

1/4" Elevator for increasing height of saddle thresholds.



3111 A, B

1/2" Elevator for increasing height of saddle thresholds.



1522 A, B

PANIC exit bumper threshold. Handicapped barrier-free design.

10 x 1" phillips flathead screws are included.

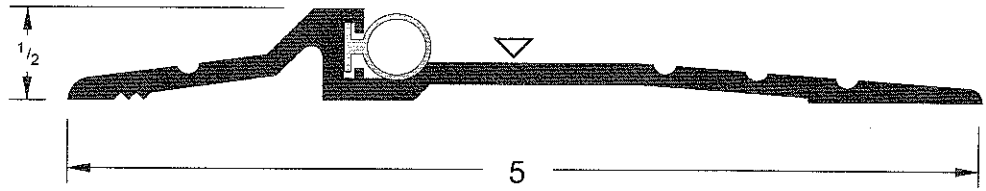

1523 A, B

10 X 1 1/2" phillips flathead screws are included.

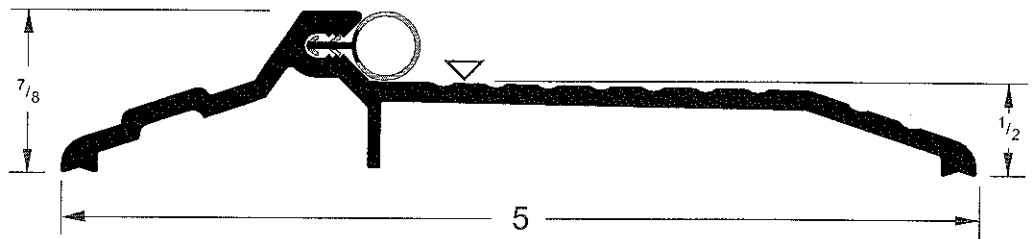

HALF SADDLE

1564 A, B

10 x 2" phillips flathead screws are included.

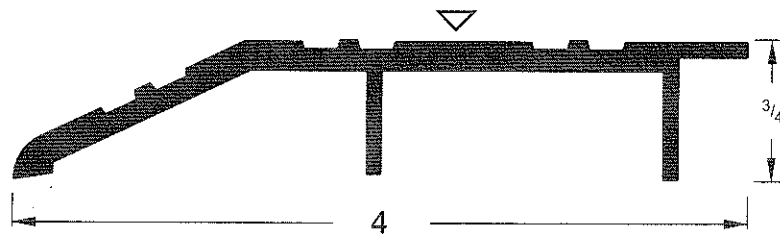

▽ Indicates location of standard fastener hole.

HEAVY DUTY COMMERCIAL SADDLE THRESHOLDS

10 x 1-1/2" phillips flathead screws are included.

1525 A, B

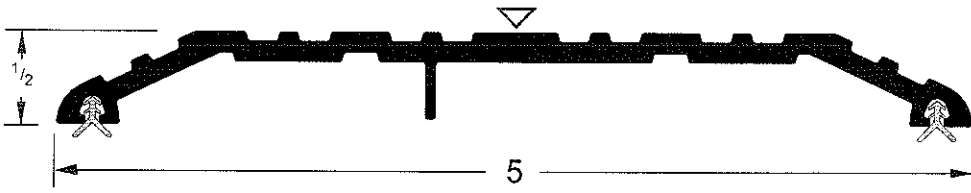

1516 A, B

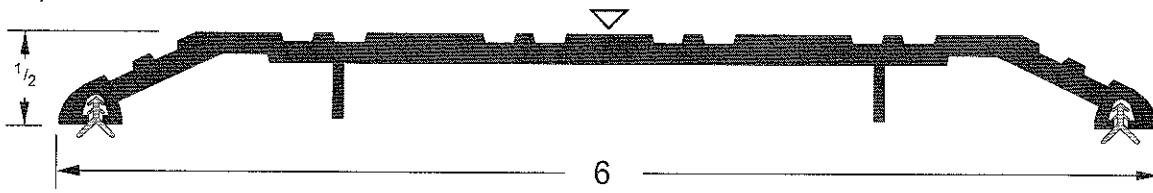

1517 A, B

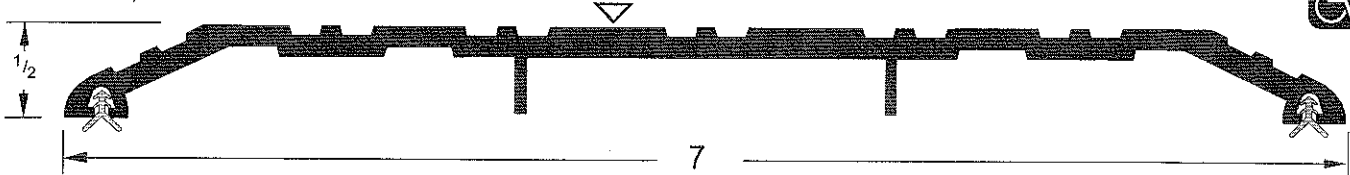

1518 A, B

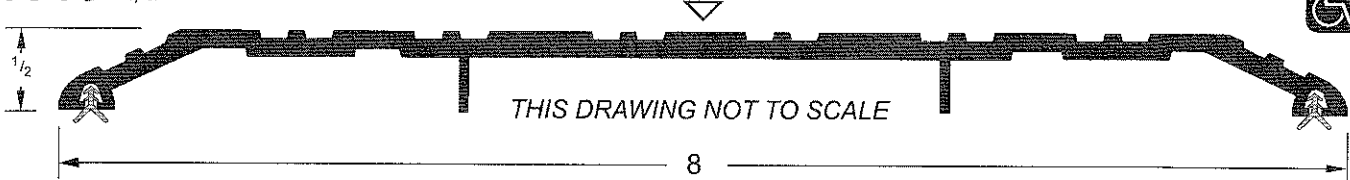

1509 A, B

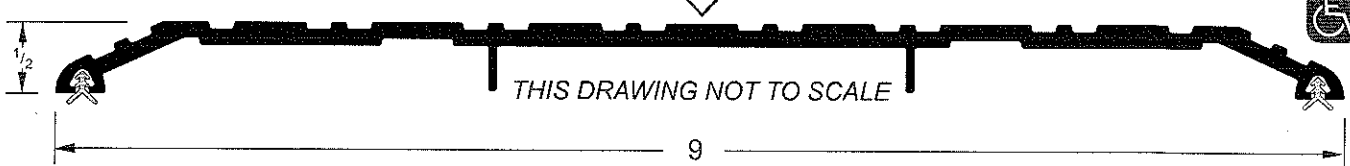

ROUT FOR METAL/MORTISED FRAMES

(RMF) A milling operation to remove aluminum, enabling the threshold to be "dropped" into place.

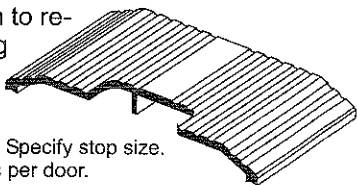

Order: Exact length required. Specify stop size.
Holes: Three (3) center holes per door.

TABS

Tabs can be attached to 1/2" commercial saddle thresholds to facilitate the connection between thresholds and wood frame.

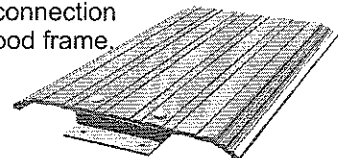

Order: Exact length required.
Holes: No center hole.

SADDLE THRESHOLDS WITH SCREW BOSS

1519 A, B

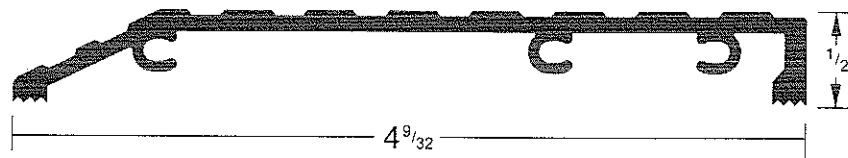

1529 A, B

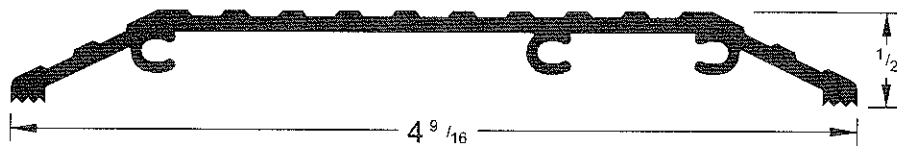

1539 A

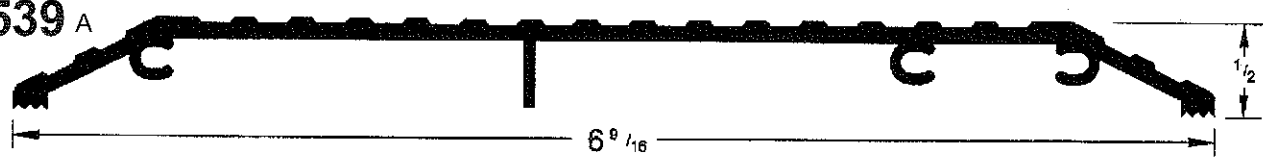

1/4" COMMERCIAL SADDLE THRESHOLDS

10 X 1" phillips flathead screws are included.

1544 A, B

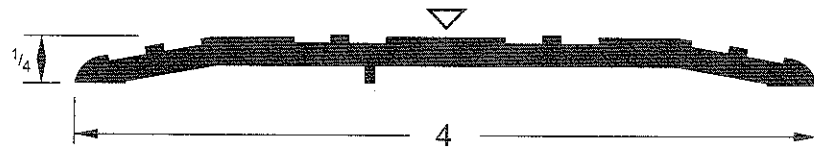

1545 A, B

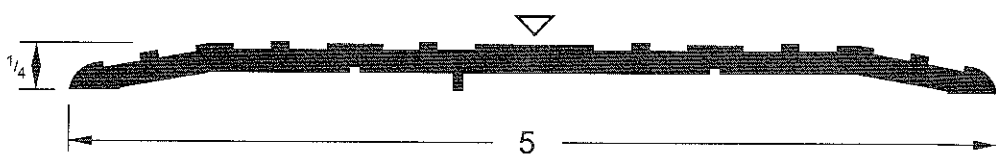

1546 A, B

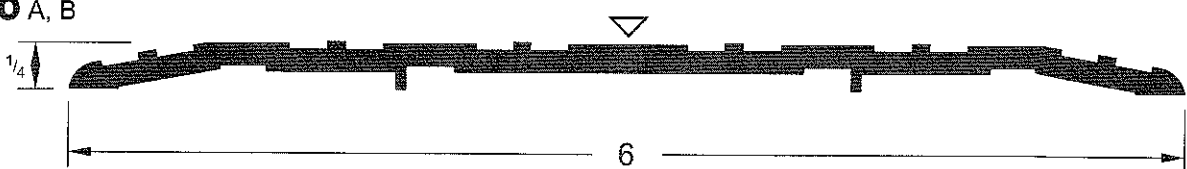

1547 A, B

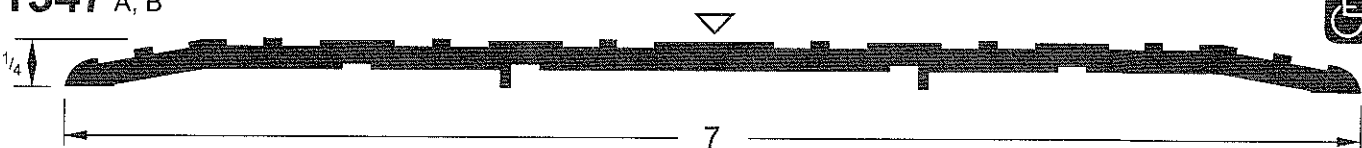

1548 A, B

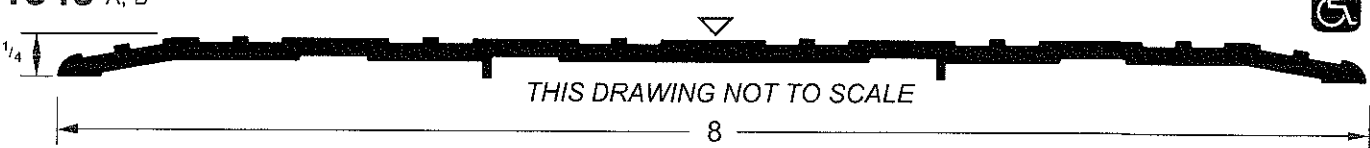

THERMAL BREAK SADDLE THRESHOLDS

10 x 1-1/2" phillips flathead screws are included.

1512 A, B

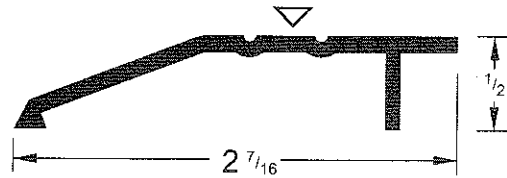

1511 P



Black rigid vinyl thermal break connector to join saddles.



1514 A, B

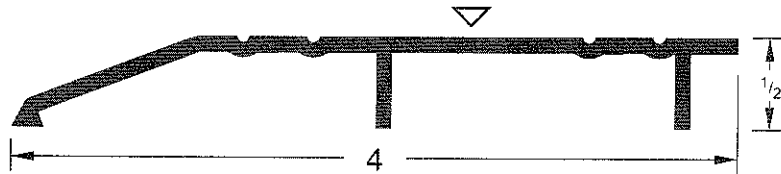

1515 A, B

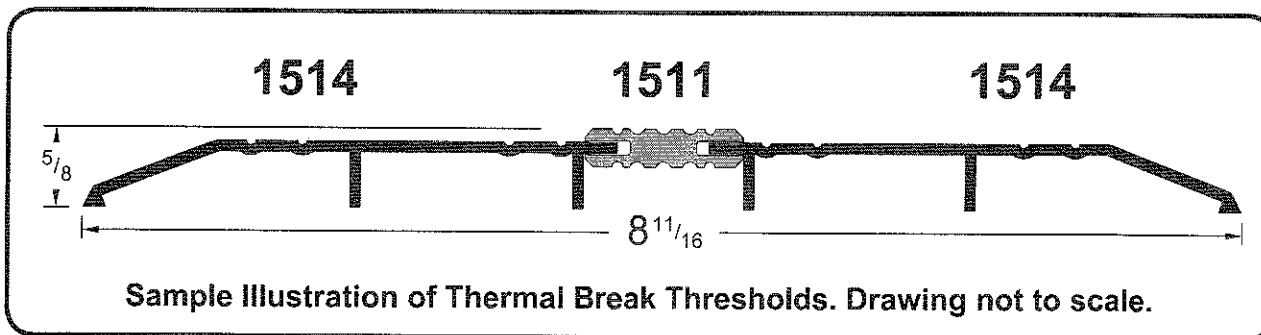
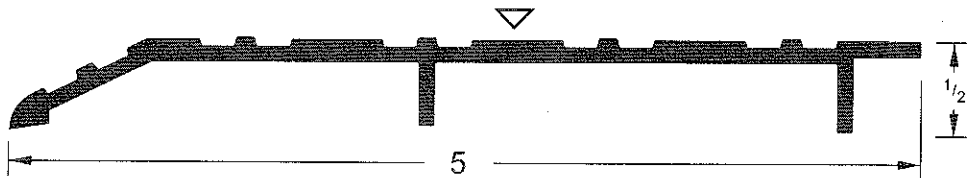

ELEVATORS

3105 A, B

1/4" Elevator for increasing height of saddle thresholds.



3111 A, B

1/2" Elevator for increasing height of saddle thresholds.



1522 A, B

PANIC exit bumper threshold. Handicapped barrier-free design.

10 x 1" phillips flathead screws are included.

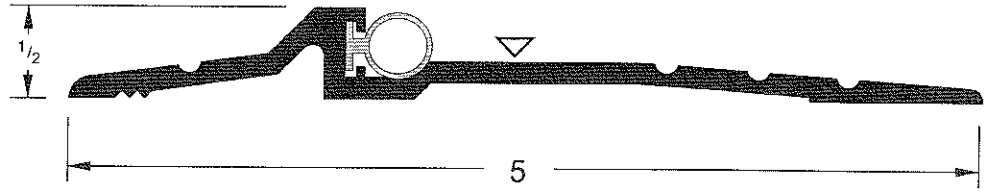

1523 A, B

10 X 1 1/2" phillips flathead screws are included.

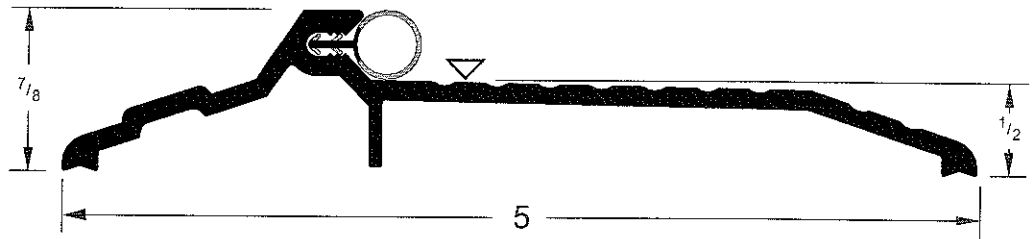

HALF SADDLE

1564 A, B

10 x 2" phillips flathead screws are included.

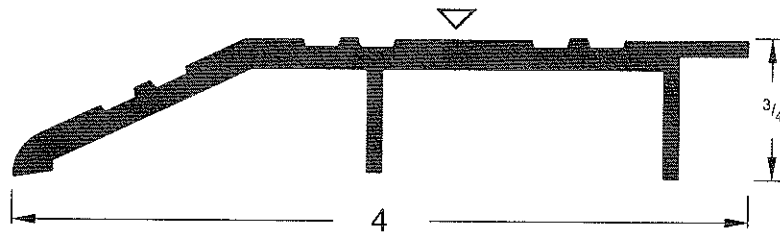

▽ Indicates location of standard fastener hole.